

# ErgoNOW™ Bottle System Key-Coded Connector Upgrade Kit

*Accessory kit used to upgrade the SmartProbe® bottle system key-coded connector to an ErgoNOW connector*

This kit is used to upgrade an existing SmartProbe® connector to an ErgoNOW™ connector. The ErgoNOW connector provides additional benefits compared to the SmartProbe connector. The ergonomically designed handle disengages the connector locks and releases the connector from the bottle system in a single, smooth motion, improving the ease of use for operators. In addition, the connector's keyed retainer assists in aligning the sensor to the sensor target on the SmartCap™ closure. ErgoNOW connectors are designed for use with the NOWPak® liner-based bottle system or PDMPak® bottle system for pressurized applications.

Note: When upgrading a SmartProbe connector to an ErgoNOW connector, both the NA-117 upgrade kit of choice and an ErgoNOW replacement keyed retainer must be ordered. The ErgoNOW PA-12-XXYYZZ (Delrin), PA-13-XXYYZZ (Noryl), PA-14-XXYYZZ (Ultem 1000), or PA-15-XXYYZZ (PEEK) keyed retainer should be ordered to match the key code of the original SmartProbe connector or intended chemistry. SmartProbe and ErgoNOW keyed retainers are not interchangeable.

## APPLICATIONS

- PL-type ErgoNOW connectors provide indirect pressure assist or pump delivery of chemical using the NOWPak liner-based bottle system.
- PD-type ErgoNOW connectors provide indirect pressure dispense using the PDMPak bottle system.



*ErgoNOW connector safely and securely provides pressure assist or pump dispense*

## FEATURES & BENEFITS

<b>Key-coded system</b>	Helps prevent dispensing the wrong material
<b>Snap on/easy release design</b>	Provides easy installation and removal of the connector
<b>Self-centering keyed retainer</b>	Ensures perfect alignment of the connector with the SmartCap closure
<b>LED</b>	Provides visual indication that the connector is installed correctly (for connectors with the sensor option)
<b>Standard pressure relief valve</b>	Provides safer system operation
<b>Safety interlock mechanism</b>	Prevents connector from accidental release during pressure dispense operation
<b>Sealed delivery system</b>	Ensures safe chemical delivery and helps prevent external contamination
<b>Upgrade kit</b>	Allows for re-use of existing products, saving money and reducing waste

## SPECIFICATIONS

<b>Materials of construction</b>	Connector body	Polypropylene	
	Gas inlet fitting	Stainless steel	
	Nozzle	Stainless steel	
	Nozzle O-ring	EPDM	
	Spring	Stainless steel	
	Screws	Stainless steel	
	Washers	Stainless steel	
	Cable tie down	LDPE	
	Danger label	Polycarbonate	
	Plug	LDPE	
	Strain relief	Nozzle	Nylon
Bracket		Polypropylene	
Screws		Stainless steel	
<b>Manufacturing standards</b>	Fabricated and tested in a Class 5 Cleanroom as per International Standard ISO 14644-1:* Cleanrooms and associated controlled environments – Part 1: Classification of air cleanliness.		
<b>Upgrade limitations and compatibility</b>	<p>SmartProbe connectors with gas inlet fitting option P cannot be upgraded due to interference between the tubing and the connector handle.</p> <p>SmartProbe connectors with liquid-out fitting options F and H (Flaretek® fitting) require ErgoNOW connector upgrade strain relief option Z (without strain relief) due to height alignment issues between the fitting and strain relief.</p>		
<b>Packaging</b>	Each NA-117-XX upgrade kit contains the ErgoNOW connector and most supporting hardware to upgrade an existing SmartProbe connector to an ErgoNOW connector. Refer to important notes on page 3 for supporting hardware guidance. Components are bagged in groups, with the whole kit double bagged and heat sealed. Shipping is performed in a corrugated container with a PE bag acting as the liner.		
<b>Labeling</b>	Each shipping carton is labeled with the part number, batch number, and quantity of upgrade kits.		
<b>Shipping information</b>	Box quantity	1	
	Box dimensions	203 mm L x 178 mm W x 178 mm H (8" L x 7" W x 7" H)	

\*ISO standard certification is kept up to date as necessary to remain current and effective to be able to demonstrate compliance with up-to-date ISO requirements.

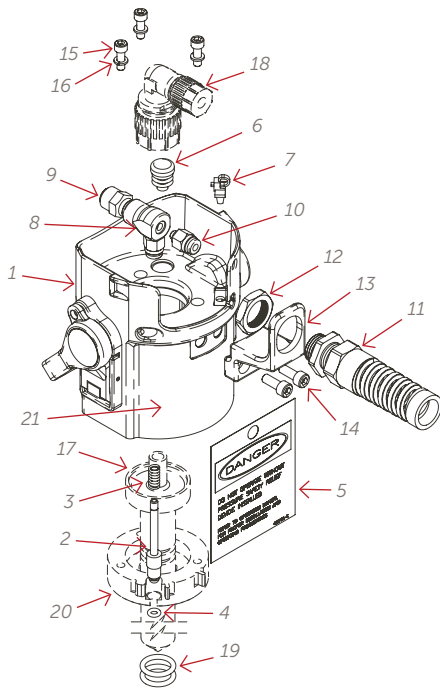

### Common Components

Item	Qty	Item description
1	1	Connector body assembly, ErgoNOW pump dispense with pressure assist
2	1	Nozzle, shouldered
3	1	Spring, compression
4	1	O-ring, nozzle, EPDM, 70 durometer
5	1	Label, "DANGER"
6	1	Plug, sensor port, LDPE
7	1	Cable tie down, push mount
8	1	Tee fitting, 1/8" NPT x #10-32 UNF x 5/32" OD QC
9	1	Valve, pressure relief, stainless steel, 7 psi
10	1	Gas inlet fitting*
11	1	Body, strain, relief**
12	1	Nut, strain, relief**
13	1	Bracket, strain, relief**
14	2	Screw, socket head cap, #10-32 x 0.50**
15	3	Screw, socket head cap, #8-32 x 0.50
16	3	Washer, split lock, #8
17	1	Probe***
18	1	Liquid out fitting***
19	2	Seal, O-ring***
20	1	Retainer, keyed, shouldered, nozzle, 3-screw****
21	1	Tie, LDPE, yellow, 0.15" LG

**Important notes:**

\* Refer to gas inlet fitting tabulation on page 5.

\*\* Items 11 – 14 are only included with the A or B strain relief options (see page 6, Ordering Information).

\*\*\* Items 17 – 19 are not included in the upgrade kit. These components are to be reused from the existing SmartProbe connector.

\*\*\*\* Item 20 is not included in the upgrade kit. When upgrading a SmartProbe connector to an ErgoNOW connector, both the NA-117 upgrade kit of choice and an ErgoNOW replacement keyed retainer must be ordered. The ErgoNOW PA-12-XXYYZZ (Delrin), PA-13-XXYYZZ (Noryl), or PA-14-XXYYZZ (Ultem 1000) keyed retainer should be ordered to match the key code of the original SmartProbe connector or intended chemistry. SmartProbe and ErgoNOW keyed retainers are not interchangeable.

## Tube Connections

	OPTIONS	DESCRIPTION
<b>Gas inlet</b>	A	$\frac{5}{32}$ " tube Quick Connect and gas fitting kit (see page 5 for additional gas fitting kit information)
	B	$\frac{1}{4}$ " tube Quick Connect (no gas fitting kit)
	C	$\frac{1}{8}$ " tube Quick Connect (no gas fitting kit)
	D	$\frac{1}{4}$ " tube Swagelok® fitting (no gas fitting kit)
	E	$\frac{1}{8}$ " FNPT thread with Quick Connect stem (no gas fitting kit)
	F	$\frac{1}{8}$ " FNPT thread (no Quick Connect stem, no gas fitting kit)
	Z	No gas inlet fitting (only the tee fitting with PRV installed)

## Gas Inlet Fitting Options

### TEE MANIFOLD WITH PRESSURE RELIEF VALVE (ALL GAS FITTING TYPES)

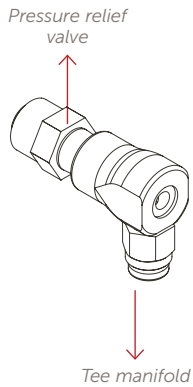

### GAS FITTING OPTION\*

### GAS FITTING

### ADDITIONAL PARTS INCLUDED – GAS FITTING KIT

A

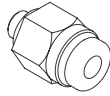

5/32" OD tube Quick Connect

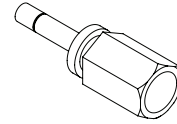

Adapter fitting, 5/32" stem to 1/8" female NPT

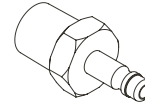

1/8" New-Machine Quick Connect stem  
(part number CA-00MP NPT 1/8")

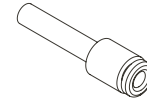

Reducer for 1/8" tube

B

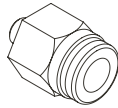

1/4" OD tube Quick Connect

C

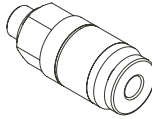

1/8" OD tube Quick Connect

D

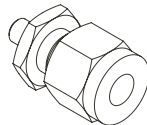

1/4" OD tube, Swagelok

E

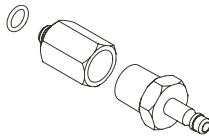

1/8" OD FNPT thread with  
Quick Connect stem

F

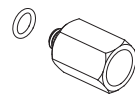

1/8" OD FNPT thread

Z

No gas inlet fitting (only the  
tee fitting with PRV installed)

\*Reference ordering information on page 7.

## DIMENSIONS

For detailed information regarding ErgoNOW connector dimensions and other information, please reference the ErgoNOW Dispense Connector data sheet.

## ORDERING INFORMATION

ErgoNOW Connector Basic Upgrade Kit: part number

*(The basic upgrade kit does not contain gas inlet or strain relief components)*

NA - 117

..... ErgoNOW connector basic upgrade – no gas inlet or strain relief

ErgoNOW Connector Upgrade Kit with Gas Inlet and Strain Relief: part number

NA - 117 -

..... **Strain relief**

- A = With strain relief for 6.35 mm (1/4") tubing
- B = With strain relief for 9.53 mm (3/8") tubing
- Z = Without strain relief

..... **Gas inlet options**

- A = 5/32" tube Quick Connect plus gas fitting kit
- B = 1/4" tube Quick Connect (no gas fitting kit)
- C = 1/8" tube Quick Connect (no gas fitting kit)
- D = 1/4" tube Swagelok fitting (no gas fitting kit)
- E = 1/8" NPT with Quick Connect stem (no gas fitting kit)
- F = 1/8" OD FNPT thread (no Quick Connect stem, no gas fitting kit)





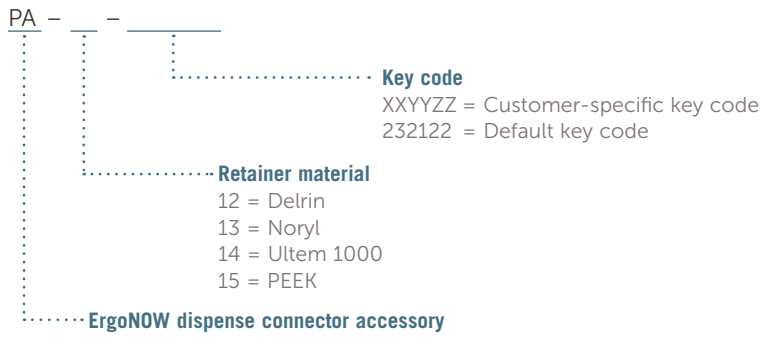

..... ErgoNOW connector upgrade

*Note: When upgrading a SmartProbe connector to an ErgoNOW connector, both the NA-117 upgrade kit of choice and an ErgoNOW replacement Keyed retainer must be ordered. The ErgoNOW PA-12-XXYYZZ (Delrin), PA-13-XXYYZZ (Noryl), PA-14-XXYYZZ (Ultem 1000), or PA-15-XXYYZZ (PEEK) keyed retainer should be ordered to match the key code of the original SmartProbe connector or intended chemistry. SmartProbe and ErgoNOW keyed retainers are not interchangeable.*

## ErgoNOW Dispense Connector Keyed Retainer Only: part number

(A replacement keyed retainer must be purchased in addition to the ErgoNOW upgrade kit when upgrading a SmartProbe connector to the ErgoNOW connector.)



PART NUMBER	PA-12-XXYYZZ*	PA-12-232122**	LKR-AA-XXYYZZ* (FOR PD-TYPE CONNECTOR)	PA-13-XXYYZZ* AND PA-13-232122**	PA-14-XXYYZZ* AND PA-14-232122**	PA-15-XXYYZZ* AND PA-15-232122**
<b>Materials of Construction</b>	Delrin	Delrin	Delrin	Noryl	Ultem 1000	PEEK
<b>Contents</b>	Retainer only	Retainer only	Retainer, stainless steel lock washers, EPDM nozzle O-ring, 1/4" retaining clip	Retainer only	Retainer only	Retainer only
<b>Retainer color</b>	Black	Red	Black	Black	Amber	Gray
<b>Retainer image</b>						

\* XXYZZ represents the customer-specific key code  
 \*\* 232122 is the default key code

### FOR MORE INFORMATION

Please call your Regional Customer Service Center today to learn what Entegris can do for you. Visit [entegris.com](http://entegris.com) and select the [Contact Us](#) link to find the customer service center nearest you.

### TERMS AND CONDITIONS OF SALE

All purchases are subject to Entegris' Terms and Conditions of Sale. To view and print this information, visit [entegris.com](http://entegris.com) and select the [Terms & Conditions](#) link in the footer.



Corporate Headquarters  
 129 Concord Road  
 Billerica, MA 01821  
 USA

Customer Service  
 Tel +1 952 556 4181  
 Fax +1 952 556 8022  
 Toll Free 800 394 4083

Entegris®, the Entegris Rings Design®, and other product names are trademarks of Entegris, Inc. as listed on [entegris.com/trademarks](http://entegris.com/trademarks). All third-party product names, logos, and company names are trademarks or registered trademarks of their respective owners. Use of them does not imply any affiliation, sponsorship, or endorsement by the trademark owner.

©2023-2024 Entegris, Inc. | All rights reserved. | Printed in the USA | 7119-11918ENT-1224