

Replacement Keyed Retainer and Kit for ErgoNOW™ Bottle System Connector

The ErgoNOW bottle system connector keyed retainer provides misconnect prevention when dispensing material using the ErgoNOW connector and the matching key-coded SmartCap™ closure

The keyed retainer component of the ErgoNOW™ connector helps ensure that the correct material is dispensed when using the ErgoNOW connector in conjunction with the SmartCap™ closure. The connector snaps into place only when the connector and closure key codes match. The replacement retainer kit allows customers the flexibility to update their connector with a new chemical key code.

APPLICATION

- ErgoNOW connector key codes are field updatable to align with a new customer chemical or material

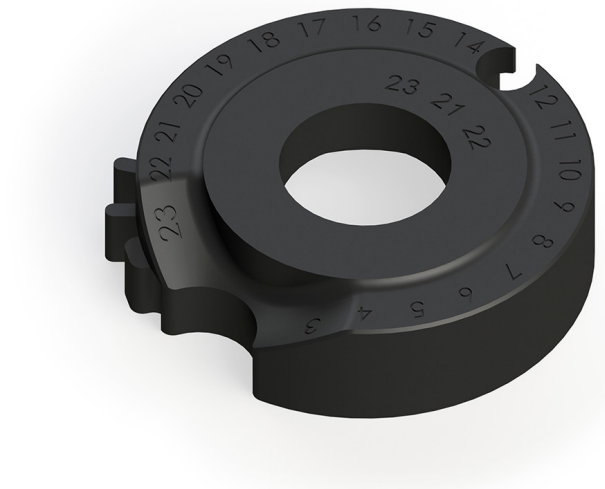





ErgoNOW keyed retainer

FEATURES & BENEFITS

- Customers can reuse their ErgoNOW dispense connector for a different chemical by replacing the key-coded retainer, saving money and reducing waste
- Key-coded systems help prevent dispensing the wrong material

SPECIFICATIONS

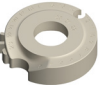
| PART NUMBER | PA-12-XXYYZZ* | PA-12-232122** | LKR-AA-XXYYZZ* (FOR PD-TYPE CONNECTOR) | PA-13-XXYYZZ* AND PA-13-232122** | PA-14-XXYYZZ* AND PA-14-232122** | PA-15-XXYYZZ* AND PA-15-232122** |
|----------------------------------|-----------------------------------------------------------------------------------|-----------------------------------------------------------------------------------|-----------------------------------------------------------------------------------|------------------------------------------------------------------------------------|-------------------------------------------------------------------------------------|-------------------------------------------------------------------------------------|
| Materials of construction | Delrin | Delrin | Delrin | Noryl | Ultem 1000 | PEEK |
| Contents | Retainer only | Retainer only | Retainer, stainless steel lock washers, EPDM nozzle O-ring, 1/4" retaining clip | Retainer only | Retainer only | Retainer only |
| Retainer color | Black | Red | Black | Black | Amber | Gray |
| Retainer image |  |  |  |  |  |  |

* XXYYZZ represents the customer-specific key code

** 232122 is the default key code

DIMENSIONS

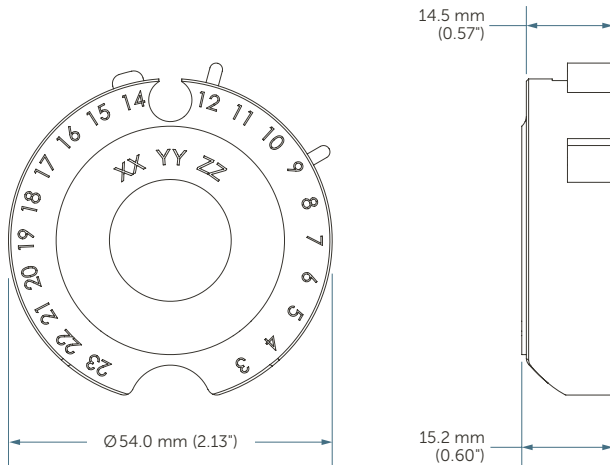

SHIPPING INFORMATION

| | |
|------------------|-----------------------------------------------------------------------------------------------------------------------------------------------------------------------------------------------------------------------------------------------------------------------------|
| Packaging | Keyed retainers are double bagged and then placed one per corrugated box and secured with bubble wrap. For LKR-AA-(key code) kit part numbers that include hardware, the hardware is bagged separately from the retainer and may be packaged up to five per corrugated box. |
| Labeling | Each carton is labeled with the part number and quantity. |

ORDERING INFORMATION

ErgoNOW Dispense Connector Keyed Retainer Only: part number

PA - -

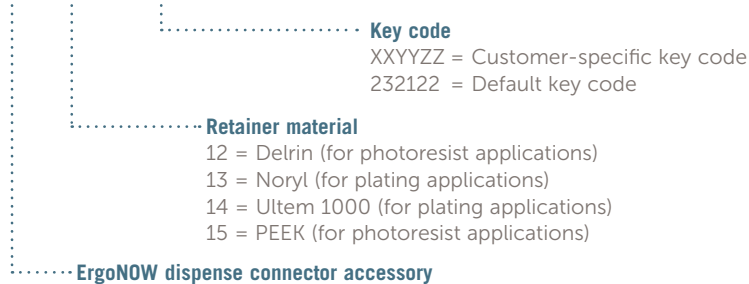

ErgoNOW Dispense Connector Keyed Retainer with Hardware: part number

(Required for updating the PD-type ErgoNOW connector)

LKR - AA -

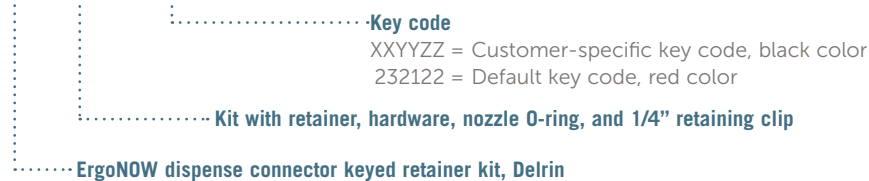

FOR MORE INFORMATION

Please call your Regional Customer Service Center today to learn what Entegris can do for you. Visit entegris.com and select the [Contact Us](#) link to find the customer service center nearest you.

TERMS AND CONDITIONS OF SALE

All purchases are subject to Entegris' Terms and Conditions of Sale. To view and print this information, visit entegris.com and select the [Terms & Conditions](#) link in the footer.



Corporate Headquarters

129 Concord Road
Billerica, MA 01821
USA

Customer Service

Tel +1 952 556 4181
Fax +1 952 556 8022
Toll Free 800 394 4083

Entegris®, the Entegris Rings Design®, and other product names are trademarks of Entegris, Inc. as listed on entegris.com/trademarks. All third-party product names, logos, and company names are trademarks or registered trademarks of their respective owners. Use of them does not imply any affiliation, sponsorship, or endorsement by the trademark owner.

©2019-2025 Entegris, Inc. | All rights reserved. | Printed in the USA | 7119-10510ENT-0225