

NOWPak[®] Bottle System

Delivering your critical materials with purity, safety, and process efficiency

The Entegris NOWPak[®] Liner-based Bottle System is a leading containment and dispense system that helps ensure that your chemicals are protected throughout the filling, shipping, and dispensing operations. The system includes a container which is a flexible liner inside a rigid overpack, a package closure, and a variety of dispense connector options. These system components work together to deliver your critical materials with purity, safety, and process efficiency.

FEATURES & BENEFITS

Purity

The NOWPak Bottle System provides the ultimate protection of critical materials. The system dispenses the chemical through a sealed pathway from the liner to the dispense tool, protecting the chemical contents from external contamination. In addition, all wetted surfaces are made from the highest purity materials, ensuring that stringent chemical quality specifications are maintained.

- All wetted surfaces are made of high purity and chemically resistant fluoropolymer materials
- Liners are manufactured and pre-cleaned in a Class 5 clean-room as per International Standard ISO 14644-1. ISO standard certification is kept up to date as necessary to remain current and effective to be able to demonstrate compliance with up-to-date ISO requirements.
- Liners can be certified for particles and trace elements
- Amber color HDPE overpacks contain a UV block additive to protect light-sensitive chemicals



NOWPak bottle system shown with the ErgoNOW™ dispense connector

Safety

The NOWPak Bottle System helps to keep employees and the environment safe. Made of durable plastics, the NOWPak container won't break like a glass bottle if dropped, avoiding the potential for a chemical spill. In addition, the sealed feature of the system prevents exposure to chemical fumes.

- High-density polyethylene (HDPE) container avoids breakage even if dropped or struck
- Double-containment (container/liner) and double seal ensures that the chemical remains in the container
- Liners are easily removed for disposal, resulting in minimal hazardous waste, and the container is designed to be recycled

Process Efficiency

The NOWPak Bottle System delivers process efficiency by minimizing material loss. The system's liner collapses as the container contents are dispensed by the connector, resulting in maximum chemical utilization. Additionally, the sealed feature of the system prevents solvent loss through evaporation.

Process efficiency is also gained through the optional feature of misconnect prevention. Two advanced options of the closure and dispense connector are available which work together to help ensure that the correct chemical is on the correct dispense tool, lowering the risk of costly errors:

1. Mechanical Misconnect Prevention—The SmartCap™ closure and ErgoNOW™ connector offer smart, unique chemical and supplier key-coding.

A key-coded dispense connector mates with a like-coded bottle closure. Material will dispense only when the bottle closure and dispense connector key-codes match.

2. Electronic Misconnect Prevention—The NOWTrak® Intelligent Material Control System includes an RFID reader in the connector which aligns with an RFID tag sealed within the closure to provide both visual and electronic indication that the connector and the package contents are a match. The NOWTrak system provides additional materials management and staging benefits.

NOWPak Bottle System Delivers on More of Your Critical Material Needs, Including:

- Containment and transport of liquids sensitive to outer environments
- Containment and transport of high-purity liquids
- High-value chemicals where bottle residue minimization is desired
- Misconnect prevention in applications where multiple chemicals are used

- Compatible with NOWTrak Intelligent Material Control System, which optimizes material management by tracking and monitoring data stored on the RFID tag
- Recycle initiatives (bottle and components designed for recycle, minimal consumable waste)

PDMPak® System for Pressurized Applications

- Designed to meet rigorous chemical input pressure requirements
- Makes pumps more efficient by maintaining positive pressure to the inlet of the pump
- Upon command, pressure delivery gas flows through the dispense connector into the region between the bottle and the liner causing compression, collapsing the liner and delivering chemical



NOWPak container

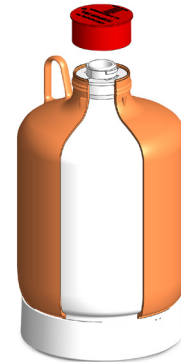

PDMPak container

NOWPak and PDMPak Bottle System Specifications

| | | | | | |
|----------------------------------|-----------------------------------------|--------------------------------------------------------------------------------------------|----------------------------------|---------------------------------------------------|------------------------------------------|
| Materials of construction | Liner | T420: PTFE T650: PTFE, one ply (20-liter size bottle only) | | | |
| | Fitment | Injection molded natural virgin PFA | | | |
| | Retainer | Injection molded natural virgin HDPE | | | |
| | Overpack | Blowmolded HDPE | | | |
| | Chime | Injection molded natural virgin HDPE (NOWPak 20-liter size and PDMPak 1- and 4-liter size) | | | |
| | Temporary cap | Injection molded LDPE | | | |
| | AVAILABLE SIZES AND CAPACITY (L) | DELIVERY METHOD | ALLOWABLE PRESSURE RATING | BOTTLE HEIGHT WITH TEMPORARY CAP (MAXIMUM) | BOTTLE OUTSIDE DIAMETER (NOMINAL) |
| NOWPak bottle system | 1 | Pump delivery with pressure assist | 34 kPa (5.0 psig)* | 235 mm (9.3") | 99 mm (3.9") |
| | 2.5 | | | 234 mm (9.2") | 149 mm (5.9") |
| | 4 | | | 268 mm (10.6") | 175 mm (6.9") |
| | 10 | | | 344 mm (13.6") | 230 mm (9.1") |
| | 20 | | | 416 mm (16.4")** | 305 mm (12.0") |
| PDMPak bottle system | 1 | Pump delivery or pressure delivery | 103 kPa (15.0 psig) maximum | 259 mm (10.2") | 99 mm (3.9") |
| | 4 | | | 300 mm (11.8") | 175 mm (6.9") |

*NOWPak bottle is not a pressure-rated vessel. Pressurization maximum of 34 kPa (5.0 psig) for two minutes.

**Distance from bottom of bottle to top of chime.

NOWPAK SYSTEM OPTIONS WITH MISCONNECT PREVENTION

NOWPak Bottle System ErgoNOW Connector

The ErgoNOW Connector works together with the SmartCap Closure to provide misconnect prevention through smart, unique chemical key-coding. The key-coding feature ensures that the connector mates with the proper closure. Unless the dispense connector and bottle closure key-codes match, chemical dispensing cannot be enabled. To make the connection more secure, the optional proximity sensor in the ErgoNOW Connector aligns with a magnet in the closure. This provides visual and electrical indication that the connector and closure match. Electronic misconnect prevention is offered as an option as part of the NOWTrak system. An RFID antenna on the ErgoNOW Connector reads the RFID tag embedded in the IntelliCap™ Closure. For assistance with setting up key-codes, please contact your Entegris customer service representative.

ErgoNOW Connector

Proximity sensor

- Aligns with magnet in the closure, to provide visual and electrical indication that the connector and closure match
- Can be interfaced with the dispense tool interlock system to further prevent misconnections

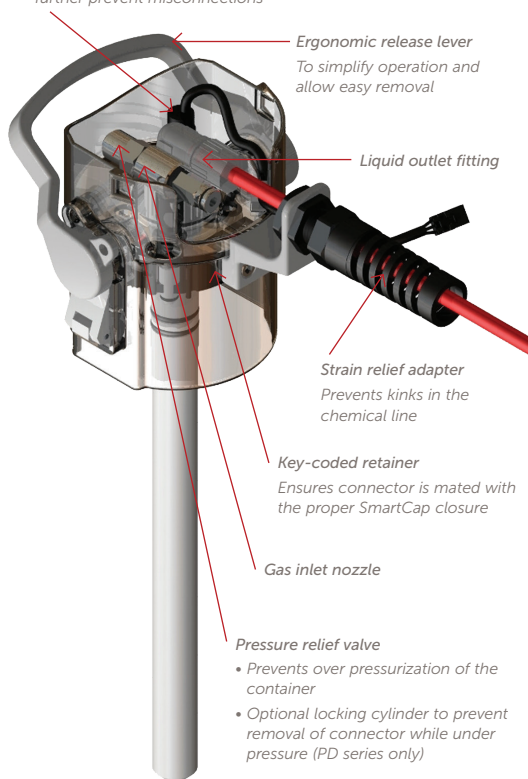

ErgoNOW dispense connector

ErgoNOW Connector Specifications

Tube connections

| | |
|------------------------------|-------------------------------------------------------------------|
| Liquid outlet | 1/4", 3/8" or 6 mm |
| Gas inlet | 1/8", 5/32" or 1/4" |
| Pressure relief valve | 48 kPa (7.0 psig) (PL series) or 138 kPa (20.0 psig) (PD series)* |

Materials of construction

| Wetted | Probe | PTFE |
|-----------|-------------------------------|--------------------------------------------------------|
| | Liquid outlet fitting | PFA |
| | Probe O-ring seals | Kalrez®, Chemraz®, or Perfrez® |
| Nonwetted | Connector body | Polypropylene |
| | Gas inlet fitting | Stainless steel |
| | Keyed retainer | Delrin®, Noryl®, Ultem® 1000, or PEEK |
| | Gas inlet nozzle O-ring seals | EPDM, Viton®, or FKM O-rings |
| | Strain relief | Nylon and polypropylene (not preassembled by Entegris) |

*Nominal cracking pressure

NA-117 ErgoNOW Upgrade Kit*

The ErgoNOW Upgrade Kit is used to upgrade an existing SmartProbe® Connector to an ErgoNOW Connector. The SmartProbe connector was the predecessor product to the ErgoNOW connector. The ErgoNOW connector provides additional benefits compared to the SmartProbe connector. The ergonomically designed handle disengages the connector locks and releases the connector from the bottle system in a single, smooth motion, improving the ease of use for operators. In addition, the connector's keyed retainer assists in alignment of the sensor and the sensor target on the SmartCap closure. Please contact your Entegris customer service representative for more information.

*NOTE: When upgrading a SmartProbe connector to an ErgoNOW connector, both the NA-117 upgrade kit of choice and an ErgoNOW replacement keyed retainer must be ordered. The ErgoNOW PA-12-XXYYZZ (Delrin), PA-13-XXYYZZ (Noryl), PA-14-XXYYZZ (Ultem 1000), or PA-15-XXYYZZ (PEEK) keyed retainer should be ordered to match the key code of the original SmartProbe connector or intended chemistry. SmartProbe and ErgoNOW keyed retainers are not interchangeable.

Keyed Retainer Replacement Kit*

The Keyed Retainer Replacement Kit allows the flexibility to change the key-coding on ErgoNOW applications where a chemical is changed. The retainer is available in Delrin, a polyoxymethylene material, Noryl, a polyphenylene oxide material, Ultem 1000, a polyetherimide material, or PEEK, a polyether ether keytone material, offering a wide range of chemical compatibility.

See the Accessories section on page 18 for a listing of available keyed retainer replacement kits.

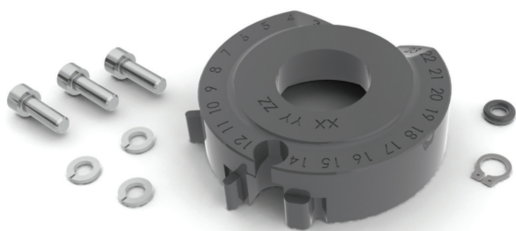

ErgoNOW keyed retainer replacement kit

**NOTE: When upgrading a SmartProbe connector to an ErgoNOW connector, both the NA-117 upgrade kit of choice and an ErgoNOW replacement keyed retainer must be ordered. The ErgoNOW PA-12-XXYYZZ (Delrin), PA-13-XXYYZZ (Noryl), PA-14-XXYYZZ (Ultem 1000), or PA-15-XXYYZZ (PEEK) keyed retainer should be ordered to match the key code of the original SmartProbe connector or intended chemistry. SmartProbe and ErgoNOW keyed retainers are not interchangeable.*

NOWPAK BOTTLE SYSTEM CLOSURES

SmartCap Closure

The smart, unique mechanical key-code mates with the ErgoNOW connector to ensure the correct chemical is connected to the correct dispense system. Materials remain sealed in the NOWPak bottle until the SmartCap tear tab is removed and the connector probe is pushed through the breakseal. This minimizes exposure of critical materials to the environment during installation of the dispense connector. For assistance with setting up key-codes, please contact your Entegris customer service representative. SmartCap closures are available with three types of breakseals: SC-, SCD- and SCG-. See the table on page 6 for additional information on breakseal types.

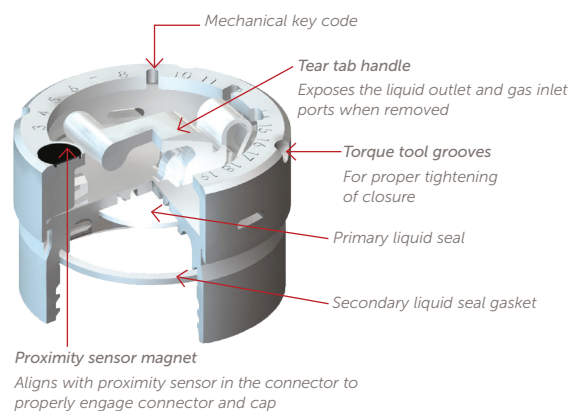

SmartCap closure

SmartCap Closure Specifications

| | |
|----------------------------|--------------------------------|
| Application torque* | 9.3 ±0.3 N•m (80–85 in•lbf) |
|----------------------------|--------------------------------|

Materials of construction

| | |
|---------------------------------|----------------------------------------------------------------------------------------------------------------------------------------------------------------------------------------------------------------------------------------------------------------|
| Closure body | LLDPE |
| Primary seal (breakseal) | <p>SC-type SmartCap: PTFE wetted surface, polyethylene foam nonwetted surface</p> <p>SCD-type SmartCap: PTFE wetted surface, polyethylene foam nonwetted surface</p> <p>SCG-type SmartCap: PTFE wetted surface, polyethylene nonwetted surface</p> |

| | |
|---------------|-------------------|
| Gasket | Polyethylene foam |
|---------------|-------------------|

| | |
|-----------------------|---------------|
| Key-coded ring | Polypropylene |
|-----------------------|---------------|

| | |
|---------------|--------------------------------|
| Target | Nickel plated neodymium magnet |
|---------------|--------------------------------|

Dimensions

| | |
|-----------------------------------|--------------|
| Outside diameter (maximum) | 72 mm (2.8") |
|-----------------------------------|--------------|

| | |
|-------------------------|--------------|
| Height (maximum) | 48 mm (1.9") |
|-------------------------|--------------|

**NOTE: It is important to observe the recommended application torque to help ensure filled bottles remain sealed.*

IntelliCap Closure

This cap option is for use with the innovative NOWTrak Intelligent Material Control System.

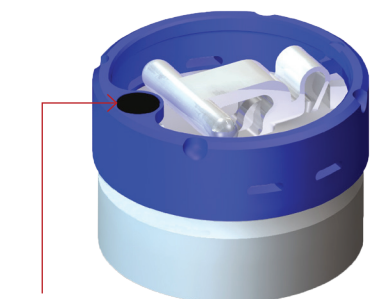

RFID Tag
Read by the RFID antenna in the ErgoNOW connector which is hard-wired to the NOWTrak control system. Chemical dispensing begins only when the chemical is identified as valid.

IntelliCap closure

IntelliCap Closure Specifications

| | |
|----------------------------|--------------------------------|
| Application torque* | 9.3 ±0.3 N•m (80–85 in•lbf) |
|----------------------------|--------------------------------|

Materials of construction

| | |
|---------------------------------|------------------------------------------------------------------------------------------------------------|
| Closure body | LLDPE |
| Primary seal (breakseal) | Pre-cleaned, laminate construction with PTFE wetted surface adhered to polyethylene foam nonwetted surface |
| Gasket | Polyethylene foam |
| Ring body | Polypropylene, blue |
| RFID memory tag | Encapsulated RFID passive memory device |

Dimensions

| | |
|-----------------------------------|--------------|
| Outside diameter (maximum) | 72 mm (2.8") |
| Height (maximum) | 48 mm (1.9") |

SmartCap and IntelliCap breakseal options

| BREAKSEAL OPTIONS | WETTED SURFACE | NONWETTED SURFACE |
|-----------------------------------------------------|------------------|----------------------------------------|
| SC-XX-YY-ZZ SmartCap and TC-W1-XX IntelliCap | PTFE surface | Laminate construction |
| SCD-XX-YY-ZZ SmartCap | PTFE surface | Donut style, laminate construction |
| SCG-XX-YY-ZZ SmartCap | PTFE surface | Donut style, laminate construction |

NA-47 and NA-47-SS SmartCap Tear Tab Removal Tool

This tool allows the operator to easily remove the tear tab from SmartCap and IntelliCap Closures. The NA-47 tool is made from Delrin material, and the NA-47-SS is made from stainless steel. For guidance on how to use this tool, please see the NOWPak Tear Tab Instruction Sheet or the ErgoNOW Connector User Guide.



NA-47 SmartCap closure tear tab removal tool

NOWPAK SYSTEM OPTIONS WITHOUT MISCONNECT PREVENTION

NOWPak Bottle System Connectors

Pressure Assist Dispense Connectors

The ND-SP, ND-SM and ND-HR connectors are thread-on style pressure assist dispense connectors designed to work with a NOWPak Bottle System container using the NC-type closures. These are commonly used with the NC-W2 removable closure, but could also be used with the NC-W1 breakseal closure.

ND-SP and ND-SM Pressure Assist Dispense Connectors

The ND-SP and ND-SM connectors are installed by removing the NC closure from the container and then inserting it into, and threading it directly onto the container. A 1/4" PFA elbow quick-disconnect gas inlet fitting with pressure assist capability permits use with pump-style delivery systems requiring priming.

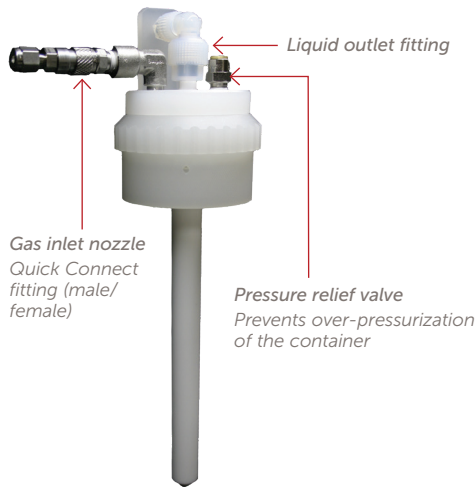

ND-SP and ND-SM dispense connector

ND-SP and ND-SM Pressure Assist Dispense Connector Specifications

Tube connections

| | |
|----------------------|------|
| Liquid outlet | 1/4" |
| Gas inlet | 1/8" |

Materials of construction

| | | |
|------------------|-------------------------|-----------------|
| Wetted | Probe | PTFE |
| | Liquid outlet fittings | PFA |
| | Probe O-ring seals | Chemraz |
| Nonwetted | Connector body | Polypropylene |
| | Gas inlet fitting | Stainless steel |
| | Gas inlet nozzle O-ring | EPDM |

ND-HR High-Flow, Recirculation Pressure Dispense Connector

The ND-HR connector is a high-flow, recirculation dispense connector that provides a clean liquid connection to NOWPak containers in pump/pressure assist applications. This style of connector is ideal for high-viscosity applications requiring pressure assist to prime the lines. It includes a return port for recirculation of fluids.

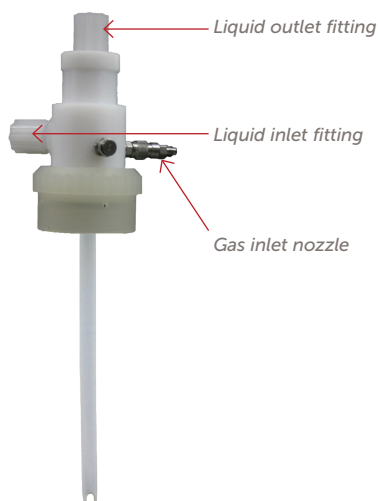

ND-HR dispense connector

ND-HR High-Flow, Recirculation Pressure Dispense Connector Specifications

Tube connections

| | |
|----------------------|---------------------|
| Liquid outlet | 1/2" or 3/8" |
| Liquid inlet | 1/2", 3/8", or none |
| Gas inlet | 1/8" or 1/4" |

Materials of construction

| Wetted | Diptube | FEP |
|------------------------|-------------------------|-----------------|
| | Probe body | PFA |
| Liquid outlet fittings | PFA | |
| Liquid inlet fittings | PFA | |
| Nonwetted | Connector body | PFA and HDPE |
| | Gas inlet fitting | Stainless steel |
| | Gas inlet nozzle O-ring | EPDM |
| | Pressure relief valve | Stainless steel |

ND-CR Recirculating Pressure Dispense Connector

The ND-CR connector is a recirculating dispense connector that provides a clean liquid connection to NOWPak containers in pump/pressure assist applications. It is for applications using low-viscosity materials.

ND-CR Recirculating Pressure Dispense Connector Specifications

Tube connections

| | |
|----------------------|-----------|
| Liquid outlet | 3/8" |
| Liquid inlet | 3/8" |
| Gas inlet | 1/4" tube |

Materials of construction

| Wetted | Diptube | FEP |
|------------------|-------------------------|--------------------------------------------------------------------------------------------------------|
| | Probe | PTFE |
| | Liquid outlet fittings | PFA |
| | Liquid inlet fittings | PFA |
| | O-ring | EPDM |
| Nonwetted | Connector body | Polypropylene |
| | Gas inlet fitting | Assembled parts made of the following materials: Stainless steel, PP, polyester, Delrin, NBR O-ring |
| | Gas inlet nozzle O-ring | EPDM |
| | Relief valve | Brass with Viton® O-ring |

Basic Pump Dispense Connector

ND-EP Basic Dispense Connector

The ND-EP basic connector is designed to snap onto the NC-W1 Breakseal Closure.

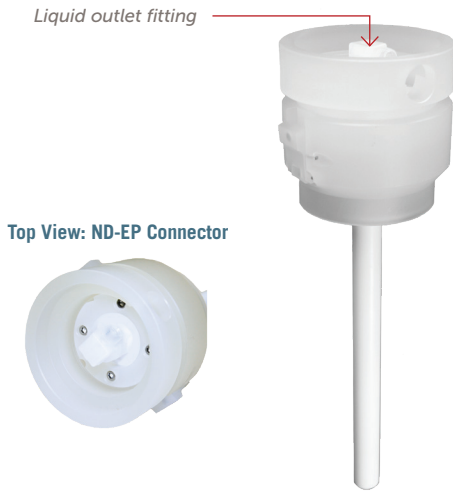

ND-EP basic dispense connector

ND-EP Basic Dispense Connector Specifications

Tube connections

| | |
|----------------------|------|
| Liquid outlet | 1/4" |
|----------------------|------|

Materials of construction

| Wetted | Probe | PTFE |
|----------------------|------------------------|---------------|
| | Liquid outlet fittings | PFA |
| Diptube O-ring seals | EPDM | |
| Nonwetted | Connector body | Polypropylene |

NOWPAK BOTTLE SYSTEM CLOSURES

NC-W2 Closure

The NC-W2 closure provides a seal for filled 1 to 20 liter NOWPak liner-based bottle systems.

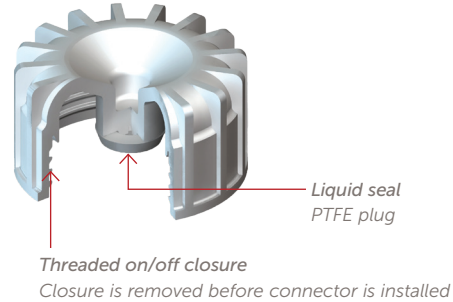

NC-W2 removable closure

NC-W2 Closure Specifications

| | |
|---------------------------|--------------------------------|
| Application torque | 9.3 ±0.3 N•m (80–85 in•lbf) |
|---------------------------|--------------------------------|

Materials of construction

| | |
|---------------------------|---------------|
| Closure body | Polypropylene |
| Liquid seal (plug) | PTFE |

Dimensions

| | |
|-----------------------------------|--------------|
| Outside diameter (maximum) | 71 mm (2.8") |
| Height (maximum) | 38 mm (1.5") |

NC-W1 Breakseal Closure

The NC-W1 Breakseal Closure is designed to work with the NOWPak Bottle System container and the ND-EP basic connector.

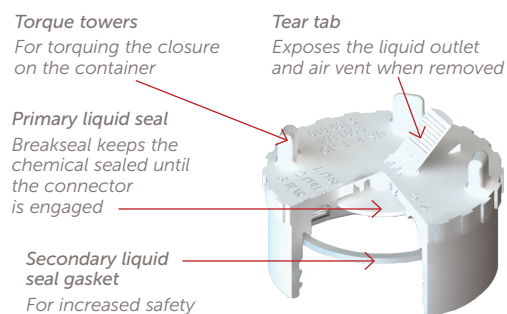

NC-W1 breakseal closure

NC-W1 Breakseal Closure Specifications

| | |
|---------------------------|--------------------------------|
| Application torque | 9.3 ±0.3 N•m (80–85 in•lbf) |
|---------------------------|--------------------------------|

Materials of construction

| | |
|---------------------------------|-------------------------------------------------------------|
| Closure body | LLDPE |
| Primary seal (breakseal) | PTFE (wetted side) laminated to nonwetted polyethylene foam |
| Secondary seal | Polyethylene foam |

Dimensions

| | |
|-----------------------------------|--------------|
| Outside diameter (maximum) | 73 mm (2.9") |
| Height (maximum) | 45 mm (1.8") |

NCD-AA-AA Dispense Closure

The shippable dispense closure is multifunctional and can be used for filling, sealing, shipping, connecting, and dispensing.

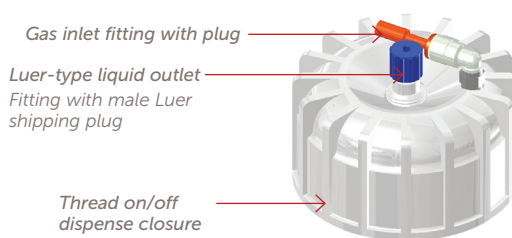

NCD-AA-AA dispense connector

NCD-AA-AA Dispense Closure Specifications

Tube connections

| | |
|----------------------|-----------------------------------------|
| Liquid outlet | Female Luer fitting with 1/8" flow path |
| Gas inlet | 1/8" tube connector |

Materials of construction

| Wetted | Cap seat adapter | HDPE |
|-----------|---------------------------------------|--------------------------------------------------------------------------------------------------|
| | Luer-type liquid outlet shipping plug | Polypropylene |
| Nonwetted | Closure body | Polypropylene |
| | Gas inlet elbow | Assembled parts made from the following materials: PBT, PP, POM, C3604, SUS304, NBR seals |
| | Gas inlet plug | Polypropylene |
| | Secondary seal O-ring | EPDM |

Dimensions

| | |
|-----------------------------------|--------------|
| Outside diameter (maximum) | 72 mm (2.9") |
| Height (maximum) | 56 mm (2.2") |

Closure matrix

| Connector | Closure | Connector Misconnect Prevention |
|---------------------------|----------------------------------------------------------------------------------------------------------------------------------------------------------------------------------------------------------|---------------------------------|
| ErgoNOW PL and PD Type | SmartCaps: SC-XX-YY-ZZ SCD-XX-YY-ZZ SCG-XX-YY-ZZ IntelliCaps: TC-W1-10 TC-W1-50 SmartCap or IntelliCap stays on bottle; connector is installed over the closure | Yes |
| ND-SP ND-SM | NC-W2, NC-W1, or SmartCap Closure is removed prior to installing connector | No |
| ND-HR | NC-W2, NC-W1, or SmartCap Closure is removed prior to installing connector | No |
| ND-CR | NC-W2, NC-W1, or SmartCap Closure is removed prior to installing connector | No |
| ND-EP | NC-W1 NC-W1 closure stays on bottle; connector is installed over the closure | No |

ORDERING INFORMATION

Contact your Entegris account representative about other available NOWPak configurations.

Containers: part number

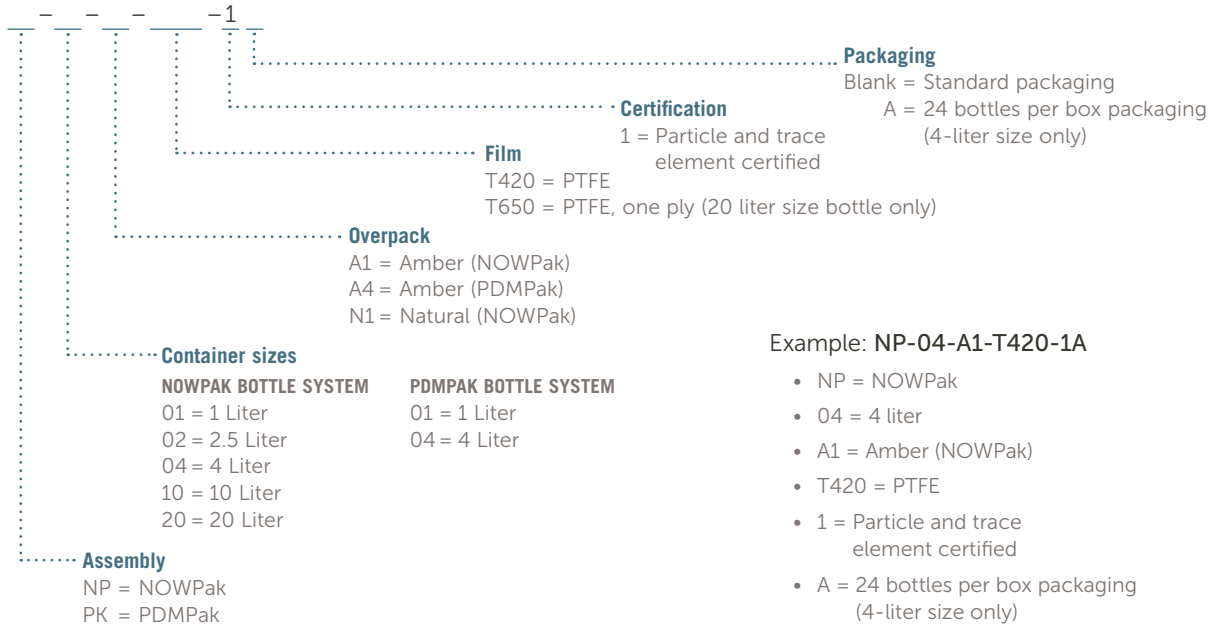

NOWPak System Replacement PTFE Liner: part number

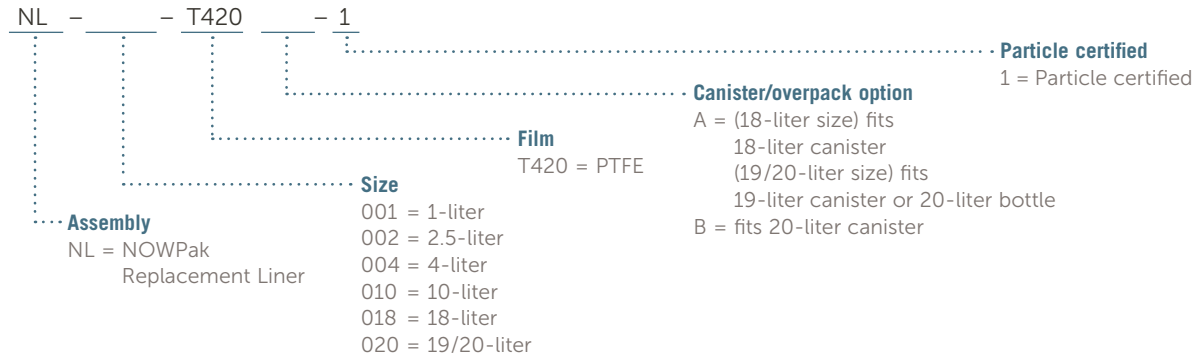

NOWPak T650 Replacement Liner: part number

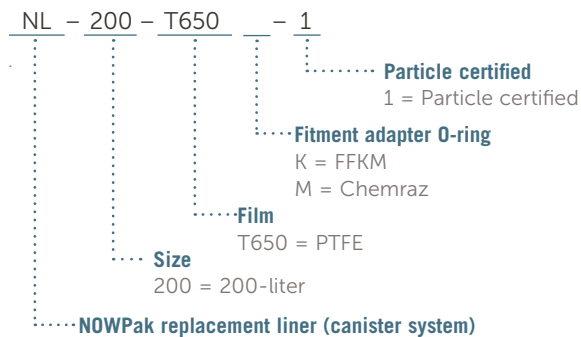
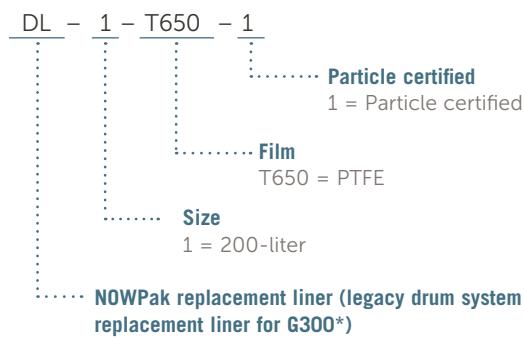
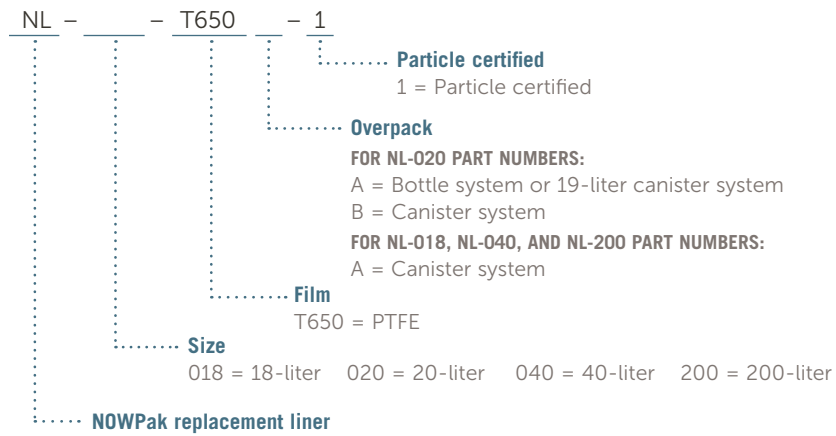

Closures

SmartCap Closure: part number

SC-XX-YY-ZZ*

SmartCap Closure with Donut Breakseal: part number

SCD-XX-YY-ZZ*

SCG-XX-YY-ZZ*

IntelliCap Closure: part number

TC-W1-__

..... **Packaging configuration**

10 = 1 bag of 10 closures per box

50 = 5 bags of 10 closures per box

NC-W1 Breakseal Closure: part number

NC-W1

NC-W2 Closure: part number

NC-W2

**XX-YY-ZZ refers to the custom key-code. Please contact your customer service representative for assistance with obtaining customer-specific key-codes.*

NOTE: See the table on page 6 for additional information regarding SmartCap and IntelliCap closure breakseal material and construction.

NCD Dispense Closure: part number

NCD-A A - AA

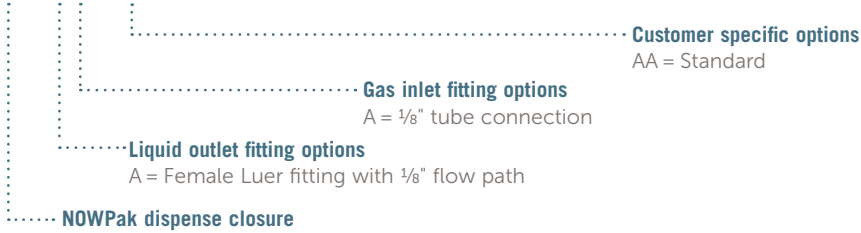

Connectors

ErgoNOW Connector: part number

P

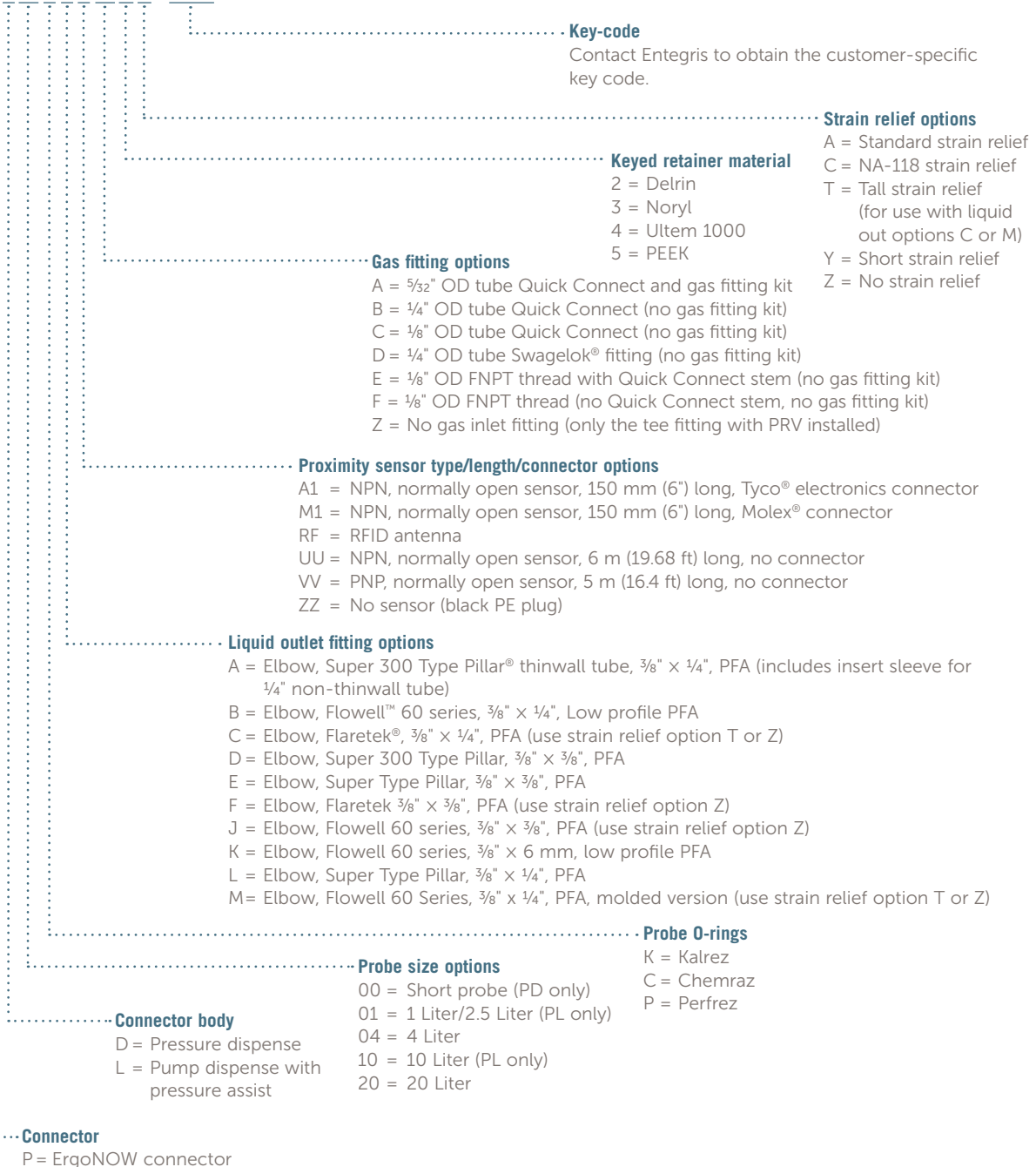

ND-HR High-Flow, Recirculation, Pressure Dispense Connector: part number

ND-HR-

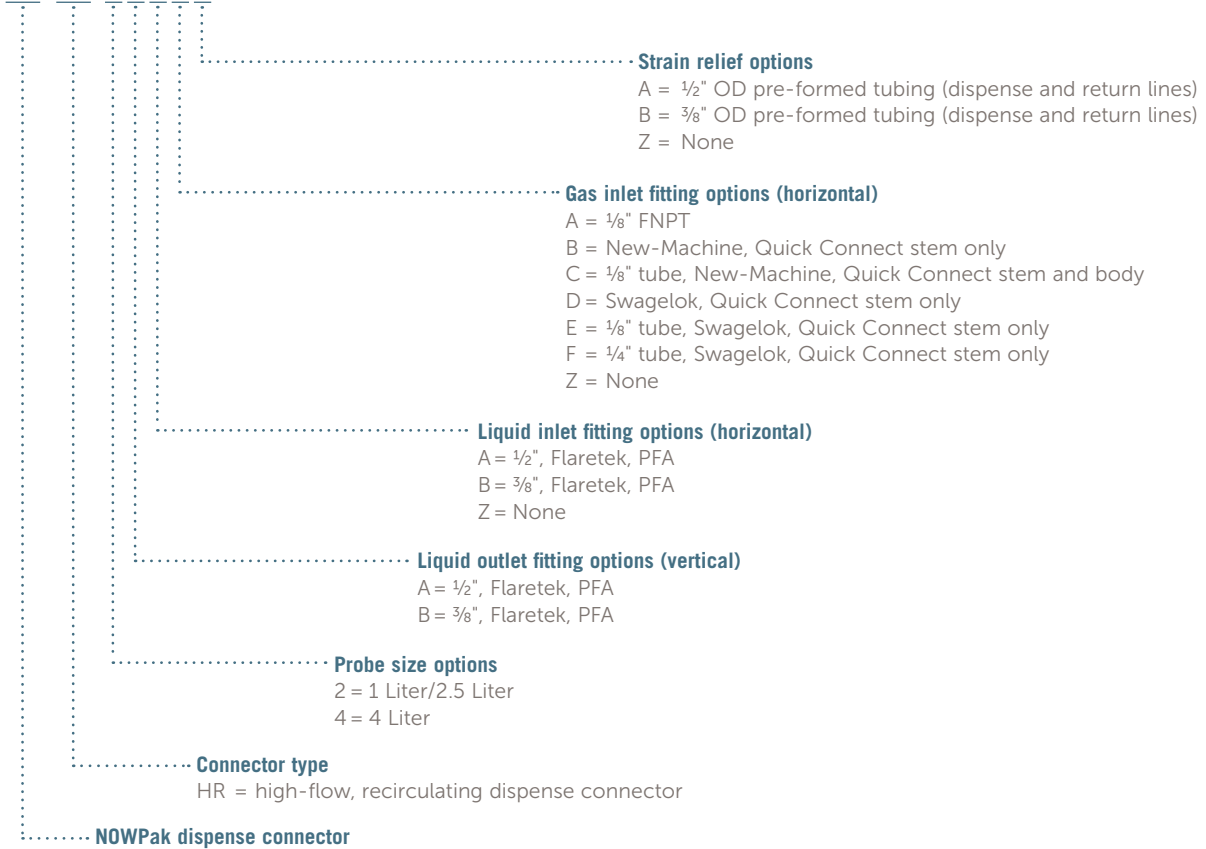

ND-CR Recirculating Pressure Assist Dispense Connectors: part number

ND-CR-

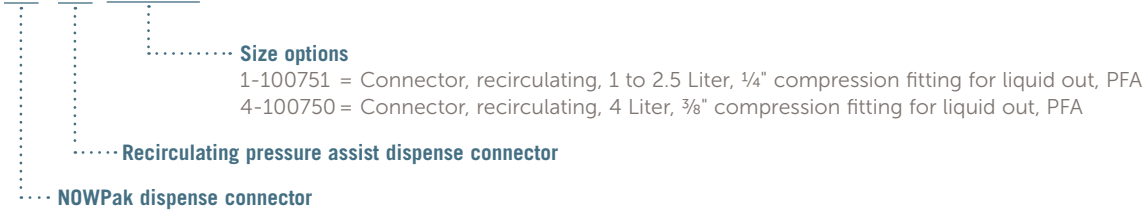

ND-SP and SM Pressure Assist Dispense Connectors: part number

ND-S-

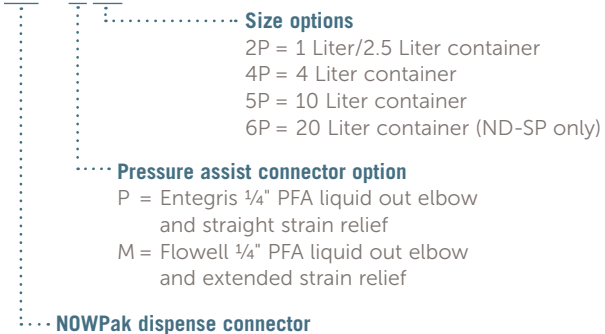

ND-EP Basic Pump Dispense Connectors: part number

ND-EP--T

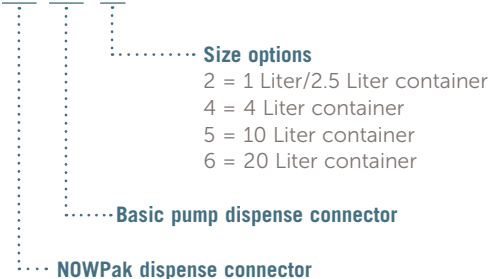

NOWPAK BOTTLE SYSTEM ACCESSORIES

Accessories

| Part number | Description |
|-------------|----------------------------------------------------------------|
| 400279-50 | Temporary cap, blue, cleaned, for NOWPak bottles, bag of 50 |
| NA-07-100 | Liner disposal plug, bag of 100 |
| NA-110-50 | Shipping ring, 2.75" tall, for NCD-AA-AA, box of 50 |
| NA-46-250 | Shipping ring, 2.25" tall, for SmartCap/IntelliCap, box of 250 |
| NA-65-100 | SmartCap disposal plug, black LDPE, bag of 100 |

Boxes

| Part number | Description |
|---------------|--------------------------------------------------------------------------------------------------------------------------------------------------------------------|
| NA-11-01-1 | UN 4G rated shipping box, for one 1-liter NOWPak bottle |
| NA-11-01-6 | UN 4G rated shipping box, for six 1-liter NOWPak bottles |
| NA-11-02-1 | UN 4G rated shipping box, for one 2.5-liter NOWPak bottle |
| NA-11-04-1 | UN 4G rated shipping box, for one 4-liter NOWPak bottle |
| NA-11-04-4 | UN 4G rated shipping box, for four 4-liter NOWPak bottles |
| NA-11-05-1 | UN 4G rated shipping box, for one 10-liter NOWPak bottle |
| NA-11-05-2 | UN 4G rated shipping box, for two 10-liter NOWPak bottles |
| NA-113-04-1 | UN 4G rated shipping box, for one 4-liter PDMPak bottle |
| NA-113-04-4 | UN 4G rated shipping box, for four 4-liter PDMPak bottles |
| NA-74-01-6 | Japanese UN 4G rated shipping box, for six 1-liter NOWPak bottles |
| NA-74-04-1 | Japanese UN 4G rated shipping box, for one 4-liter NOWPak bottle |
| NA-74-04-4 | Japanese UN 4G rated shipping box, for four 4-liter NOWPak bottles |
| NA-74-05-1 | Japanese UN 4G rated shipping box, for one 10-liter NOWPak bottle |
| NA-74-05-2 | Japanese UN 4G rated shipping box, for two 10-liter NOWPak bottles |
| NA-70-04-4-F6 | Secondary protective packaging kit for use with NA-11-04-4 or NA-74-04-4 4-liter NOWPak bottle boxes. Contains top and bottom foam crowns and secondary outer box. |

Keyed Retainer Kits, ErgoNOW Connectors*

| Part number** | Description |
|---------------|-----------------------------------------------------------------------------------------------------------------------------------------------|
| PA-12-XXYYZZ | Replacement keyed Delrin retainer for ErgoNOW connector |
| LKR-AA-XXYYZZ | Kit, keyed Delrin retainer with hardware, retaining clip, and nozzle O-ring for ErgoNOW connector (required for PD-type ErgoNOW connector) |
| PA-13-XXYYZZ | Replacement keyed Noryl retainer for ErgoNOW connector |
| PA-14-XXYYZZ | Replacement keyed Ultem 1000 retainer for ErgoNOW connector |
| PA-15-XXYYZZ | Replacement keyed PEEK retainer for ErgoNOW connector |

Keyed Retainer Kits, SmartProbe Connectors

| Part number** | Description |
|---------------|----------------------------------------------------------------------------------------------------------|
| NA-125-XXYYZZ | Replacement keyed Delrin retainer for SmartProbe connector |
| NA-126-XXYYZZ | Replacement keyed Noryl retainer for SmartProbe connector |
| SKR-A-XXYYZZ | Kit, keyed Delrin retainer with EPDM probe O-ring, hardware, and nozzle O-ring, for SmartProbe connector |

Upgrade Kits*

| Part number | Description |
|-------------|----------------------------------------------------------------------------------------------------|
| NA-117 | Upgrade kit, converts SmartProbe to ErgoNOW connector, no gas inlet fitting or strain relief |
| NA-117-AA | Upgrade kit, converts SmartProbe to ErgoNOW connector, with gas inlet fitting and strain relief |
| NA-117-EA | Upgrade kit, converts SmartProbe to ErgoNOW connector with gas fitting option E, and strain relief |
| NA-117-FA | Upgrade kit, converts SmartProbe to ErgoNOW connector with gas fitting option F, and strain relief |

*NOTE: When upgrading a SmartProbe connector to an ErgoNOW connector, both the NA-117 upgrade kit of choice and an ErgoNOW replacement keyed retainer must be ordered. The ErgoNOW PA-12-XXYYZZ (Delrin), PA-13-XXYYZZ (Noryl), PA-14-XXYYZZ (Ultem 1000), or PA-15-XXYYZZ (PEEK) keyed retainer should be ordered to match the key code of the original SmartProbe connector or intended chemistry. SmartProbe and ErgoNOW keyed retainers are not interchangeable.

**XXYYZZ represents the customer specific key-code. Contact an Entegris customer service representative for the six-digit key-code assignment.

Replacement Parts

| Part number | Description |
|-------------|------------------------------------------------------------------------------------------------|
| 201153-C | Replacement O-ring for ErgoNOW pressure assist nozzle, quantity of one |
| 400765-C | Gas fitting component, stainless steel bulkhead adapter fitting for 1/8", New-Machine, cleaned |
| 401209-C | Replacement stainless steel shouldered nozzle, for ErgoNOW dispense connectors |
| 401321 | Strain relief bracket, large, molded, for ErgoNOW dispense connectors |
| PA-06 | Replacement ErgoNOW connector probe O-ring, Kalrez, bag of 2 |
| PA-09-AX | Gas inlet fitting assembly Option A, for ErgoNOW connector |

Tools

| Part number | Description |
|-----------------|---------------------------------------------------------------------------------------------------------------------------------------------------------------------------------------------------------------------------------|
| NA-02 | Torque tool adapter for NC-W1 breakseal style closure (fits on a 1/2" drive torque wrench) |
| NA-03 | Torque tool adapter for NC-W2 thread-on/off style closure (fits on a 1/2" drive torque wrench) |
| NA-03-NCD | Torque tool, adapter for NCD-AA-AA dispense connector (fits on a 1/2" drive torque wrench) |
| NA-06 | Liner removal tool |
| NA-17 | Tool, liner removal/drain |
| NA-22 | Tear tab removal tool for use with NC-W1 breakseal closure |
| NA-27 | Kit, O-ring removal tools |
| NA-33 | Torque wrench, 3/8", 0–150 lbf•in, with 3/8" to 1/2" drive socket adapter |
| NA-41 | Liner inflation connector for bottle or canister systems |
| NA-42 | Torque tool adapter for SmartCap and IntelliCap |
| NA-47 | Tear tab removal tool for SmartCap, Delrin |
| NA-47-SS | Tear tab removal tool for SmartCap, stainless steel |
| NA-51 | Torque tool adapter for SmartCap and IntelliCap closures, includes 1/2" torque drive adaptor |
| NA-51-A-XXYYZZ* | Torque tool for SmartCap and IntelliCap closures with keyed insert. Contains NA-51 torque tool body, and NA-51-XXYYZZ keyed insert. NA-51 and NA-51-XXYYZZ are also available for sale separately. (XXYYZZ represents key-code) |
| NA-51-XXYYZZ* | Keyed insert for NA-51-A-XXYYZZ SmartCap torque tool (XXYYZZ represents key-code) |

*XXYYZZ represents the customer specific key-code. Contact an Entegris customer service representative for the six-digit key-code assignment.

LIMITED WARRANTY

Entegris' products are subject to the Entegris, Inc. General Limited Warranty. To view and print this information, visit [entegris.com](https://www.entegris.com) and select the [Legal & Trademark Notices](#) link in the footer. Entegris does not warranty any failure in the case of customers using unapproved foreign components.

FOR MORE INFORMATION

Please call your Regional Customer Service Center today to learn what Entegris can do for you. Visit [entegris.com](https://www.entegris.com) and select the [Contact Us](#) link to find the customer service center nearest you.

TERMS AND CONDITIONS OF SALE

All purchases are subject to Entegris' Terms and Conditions of Sale. To view and print this information, visit [entegris.com](https://www.entegris.com) and select the [Terms & Conditions](#) link in the footer.



Corporate Headquarters
129 Concord Road
Billerica, MA 01821
USA

Customer Service
Tel +1 952 556 4181
Fax +1 952 556 8022
Toll Free 800 394 4083

Entegris®, the Entegris Rings Design®, and other product names are trademarks of Entegris, Inc. as listed on [entegris.com/trademarks](https://www.entegris.com/trademarks). All third-party product names, logos, and company names are trademarks or registered trademarks of their respective owners. Use of them does not imply any affiliation, sponsorship, or endorsement by the trademark owner.

©2009-2024 Entegris, Inc. | All rights reserved. | Printed in the USA | 7119-7791ENT-1124